

DESCRIPTION

The HCPL-0500, HCPL-0501 and HCPL-0452 optocouplers consist of an AlGaAs LED optically coupled to a high speed photodetector transistor housed in a compact 8-pin smalloutline package.

A separate connection for the bias of the photo-diode improves the speed by several orders of magnitude over conventional phototransistor optocouplers by reducing the base-collector capacitance of the input transistor.

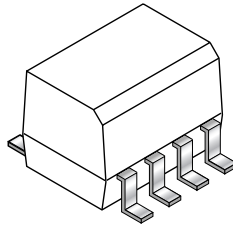

FEATURES

- High speed-1 MBit/s
- Superior CMR-1 kV/μs
- CTR guaranteed 0-70°C
- U.L. recognized (File # E90700)

APPLICATIONS

- Line receivers
- Pulse transformer replacement
- Output interface to CMOS-LSTTL-TTL
- Wide bandwidth analog coupling

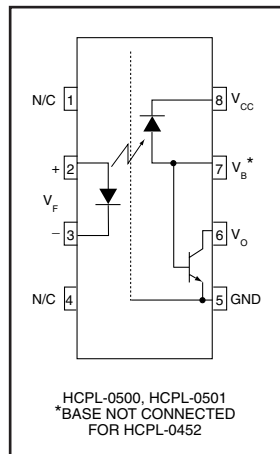

SINGLE-CHANNEL

**HCPL-0500
HCPL-0501**

HCPL-0452

Package Dimensions

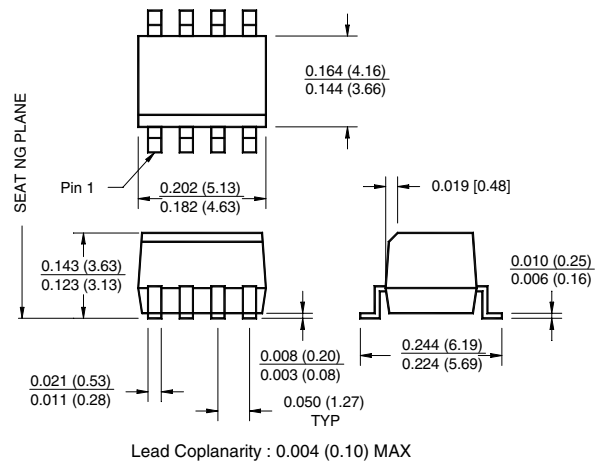

NOTE

All dimensions are in inches (millimeters)

ABSOLUTE MAXIMUM RATINGS ($T_A = 25^\circ\text{C}$ unless otherwise specified)

Parameter	Symbol	Value	Units
Storage Temperature	T_{STG}	-55 to +125	°C
Operating Temperature	T_{OPR}	-55 to +100	°C
Reflow Temperature Profile (Refer to fig. 11)			
EMITTER			
DC/Average Forward Input Current	I_F (avg)	25	mA
Peak Forward Input Current (50% duty cycle, 1 ms P.W.)	I_F (pk)	50	mA
Peak Transient Input Current - ($\leq 1 \mu\text{s}$ P.W., 300 pps)	I_F (trans)	1.0	A
Reverse Input Voltage	V_R	5	V
Input Power Dissipation	P_D	45	mW
DETECTOR			
Average Output Current (Pin 6)	I_O (avg)	8	mA
Peak Output Current	I_O (pk)	16	mA
Emitter-Base Reverse Voltage (Except HCPL-0452)	V_{EBR}	5	V
Supply Voltage	V_{CC}	-0.5 to 30	V
Output Voltage	V_O	-0.5 to 20	V
Base Current (Except HCPL-0452)	I_B	5	mA
Output power dissipation	P_D	100	mW

SINGLE-CHANNEL
HCPL-0500 HCPL-0452
HCPL-0501

ELECTRICAL CHARACTERISTICS ($T_A = 0$ to 70°C Unless otherwise specified)

INDIVIDUAL COMPONENT CHARACTERISTICS

Parameter	Test Conditions	Symbol	Device	Min	Typ**	Max	Unit
EMITTER	($I_F = 16$ mA, $T_A = 25^\circ\text{C}$)	V_F	All		1.45	1.7	V
Input Forward Voltage	($I_F = 16$ mA)					1.8	
Input Reverse Breakdown Voltage	($I_R = 10$ μA)	BV_R	All	5.0			V
Temperature coefficient of forward voltage	($I_F = 16$ mA)	$(\Delta V_F / \Delta T_A)$	All		-1.6		mV/ $^\circ\text{C}$
DETECTOR							
Logic high output current	($I_F = 0$ mA, $V_O = V_{CC} = 5.5$ V) ($T_A = 25^\circ\text{C}$)	I_{OH}	All		0.001	0.5	μA
	($I_F = 0$ mA, $V_O = V_{CC} = 15$ V) ($T_A = 25^\circ\text{C}$)		All		0.005	1	
	($I_F = 0$ mA, $V_O = V_{CC} = 15$ V)		All			50	
Logic low supply current	($I_F = 16$ mA, $V_O = \text{Open}$) ($V_{CC} = 15$ V)	I_{CCL}	All		120	200	μA
Logic high supply current	($I_F = 0$ mA, $V_O = \text{Open}$, $V_{CC} = 15$ V) ($T_A = 25^\circ\text{C}$)	I_{CCH}	All		0.01	1	μA
	($I_F = 0$ mA, $V_O = \text{Open}$) ($V_{CC} = 15$ V)		All			2	

TRANSFER CHARACTERISTICS ($T_A = 0$ to 70°C Unless otherwise specified)

Parameter	Test Conditions	Symbol	Device	Min	Typ**	Max	Unit
COUPLED							
Current transfer ratio (Note 5)	($I_F = 16$ mA, $V_O = 0.4$ V) ($V_{CC} = 4.5$ V, $T_A = 25^\circ\text{C}$)	CTR	HCPL-0500	7	27	50	%
			HCPL-0452	19	27	50	
			HCPL-0501				
	($I_F = 16$ mA, $V_O = 0.5$ V) ($V_{CC} = 4.5$ V)		HCPL-0500	5	30		
			HCPL-0452	15	30		
			HCPL-0501				
Logic low output voltage output voltage	($I_F = 16$ mA, $I_O = 1.1$ mA) ($V_{CC} = 4.5$ V, $T_A = 25^\circ\text{C}$)	V_{OL}	HCPL-0500		0.18	0.4	V
			HCPL-0452 HCPL-0501		0.25	0.4	
	HCPL-0500				0.13	0.5	
	($I_F = 16$ mA, $I_O = 0.8$ mA) ($V_{CC} = 4.5$ V)		HCPL-0452		0.23	0.5	
			HCPL-0501				
	($I_F = 16$ mA, $I_O = 2.4$ mA) ($V_{CC} = 4.5$ V)						

** All typicals at $T_A = 25^\circ\text{C}$

**SINGLE-CHANNEL
HCPL-0500 HCPL-0452
HCPL-0501**

SWITCHING CHARACTERISTICS ($T_A = 0$ to 70°C unless otherwise specified., $V_{CC} = 5\text{ V}$)									
Parameter	Test Conditions	Symbol	Device	Min	Typ**	Max	Unit		
Propagation delay time to logic low	$T_A = 25^\circ\text{C}$, ($R_L = 4.1\text{ k}\Omega$, $I_F = 16\text{ mA}$) (Note 6) (Fig. 9)	T_{PHL}	HCPL-0500		0.45	1.5	μs		
			HCPL-0452		0.45	0.8			
	HCPL-0501								
	$T_A = 25^\circ\text{C}$		$(R_L = 1.9\text{ k}\Omega$, $I_F = 16\text{ mA})$ (Note 7) (Fig. 9)	HCPL-0500				2.0	
				HCPL-0452					
	HCPL-0501					1.0			
Propagation delay time to logic high	$T_A = 25^\circ\text{C}$, ($R_L = 4.1\text{ k}\Omega$, $I_F = 16\text{ mA}$) (Note 6) (Fig. 9)	T_{PLH}	HCPL-0500		0.5	1.5	μs		
			HCPL-0452		0.3	0.8			
	HCPL-0501								
	$T_A = 25^\circ\text{C}$		$(R_L = 1.9\text{ k}\Omega$, $I_F = 16\text{ mA})$ (Note 7) (Fig. 9)	HCPL-0500				2.0	
				HCPL-0452					
	HCPL-0501					1.0			
Common mode transient immunity at logic high	$(I_F = 0\text{ mA}$, $V_{CM} = 10\text{ V}_{P-P}$, $R_L = 4.1\text{ k}\Omega$) (Note 8) (Fig. 10) $T_A = 25^\circ\text{C}$	ICM_{HI}	HCPL-0500		1,000		$\text{V}/\mu\text{s}$		
			HCPL-0452		1,000				
			HCPL-0501						
Common mode transient immunity at logic low	$(I_F = 16\text{ mA}$, $V_{CM} = 10\text{ V}_{P-P}$, $R_L = 4.1\text{ k}\Omega$) (Note 8) (Fig. 10) $T_A = 25^\circ\text{C}$	ICM_{LI}	HCPL-0500		1,000		$\text{V}/\mu\text{s}$		
			HCPL-0452		1,000				
			HCPL-0501						

ISOLATION CHARACTERISTICS ($T_A = 0^\circ\text{C}$ to $+70^\circ\text{C}$ Unless otherwise specified.)						
Characteristics	Test Conditions	Symbol	Min	Typ**	Max	Unit
Input-Output Isolation Voltage	$(f = 60\text{ Hz}$, $t = 1.0\text{ min})$ (9,10)	V_{ISO}	2500	—	—	Vac_{RMS}
Isolation Resistance	$(V_{I-O} = 500\text{ V})$ (9)	R_{ISO}	10^{11}	—	—	Ω
Isolation Capacitance	$(V_{I-O} = 0$, $f = 1.0\text{ MHz})$ (9)	C_{ISO}	—	0.2	—	pF

** All typicals at $T_A = 25^\circ\text{C}$

SINGLE-CHANNEL

HCPL-0500

HCPL-0452

HCPL-0501

NOTES

1. Derate linearly above 70°C free-air temperature at a rate of 0.8 mA/°C.
2. Derate linearly above 70°C free-air temperature at a rate of 1.6 mA/°C.
3. Derate linearly above 70°C free-air temperature at a rate of 0.9 mW/°C.
4. Derate linearly above 70°C free-air temperature at a rate of 2.0 mW/°C.
5. Current Transfer Ratio is defined as a ratio of output collector current, I_O , to the forward LED input current, I_F , times 100%.
6. The 4.1 k Ω load represents 1 LSTTL unit load of 0.36 mA and 6.1k Ω pull-up resistor.
7. The 1.9 k Ω load represents 1 TTL unit load of 1.6 mA and 5.6 k Ω pull-up resistor.
8. Common mode transient immunity in logic high level is the maximum tolerable (positive) dV_{CM}/dt on the leading edge of the common mode pulse signal V_{CM} , to assure that the output will remain in a logic high state (i.e., $V_O > 2.0$ V). Common mode transient immunity in logic low level is the maximum tolerable (negative) dV_{CM}/dt on the trailing edge of the common mode pulse signal, V_{CM} , to assure that the output will remain in a logic low state (i.e., $V_O < 0.8$ V).
9. Device is considered a two terminal device: Pins 1, 2, 3 and 4 are shorted together and Pins 5, 6, 7 and 8 are shorted together.
10. 2500 VAC RMS for 1 minute duration is equivalent to 3000 VAC RMS for 1 second duration.

SINGLE-CHANNEL
HCPL-0500 HCPL-0452
HCPL-0501

Fig. 1 Input Forward Current vs. Input Forward Voltage

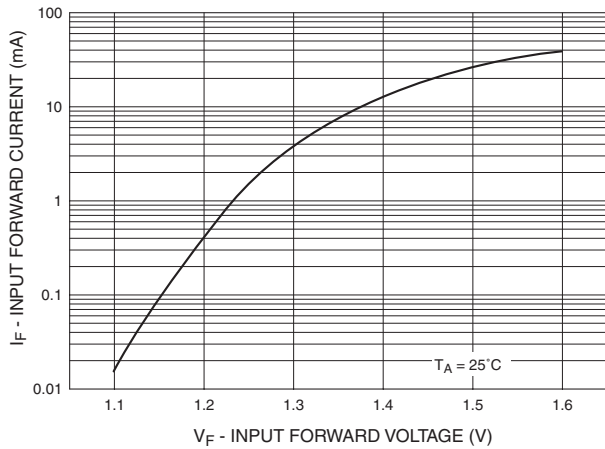

Fig. 2 Current Transfer Ratio vs. Input Current

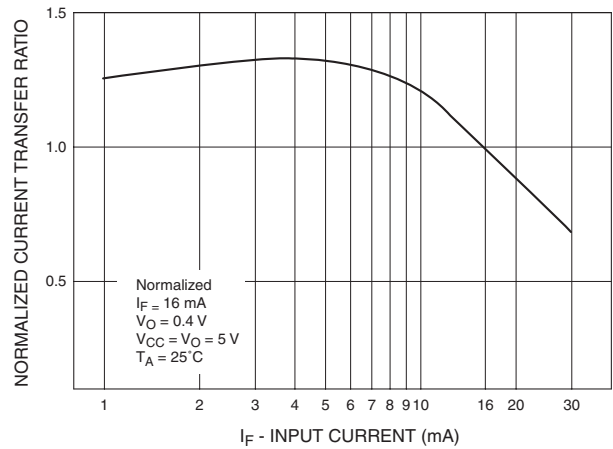

Fig. 3 Current Transfer Ratio vs. Input Forward Current

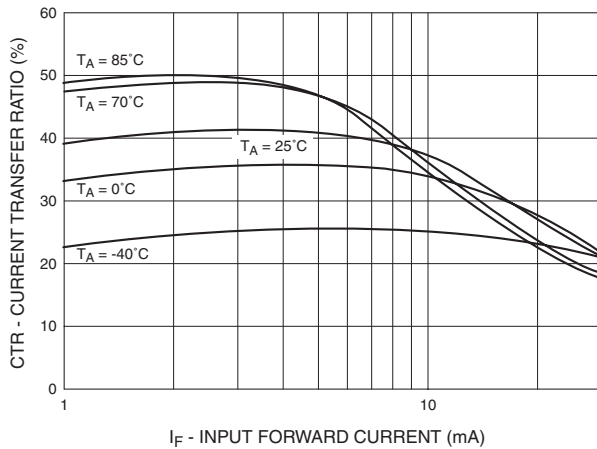
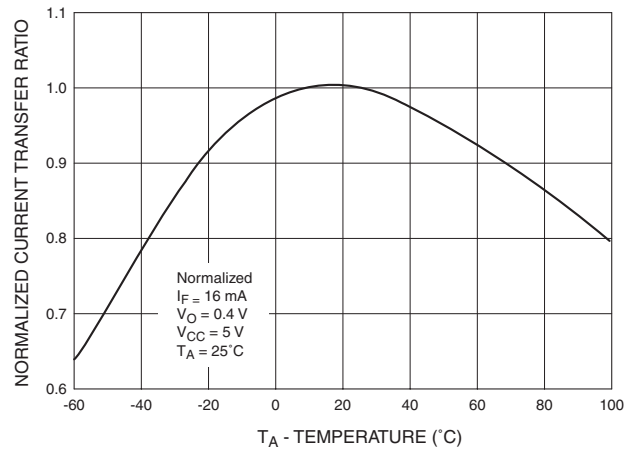

Fig. 4 Current Transfer Ratio vs. Temperature



SINGLE-CHANNEL
HCPL-0500 HCPL-0452
HCPL-0501

Fig. 5 DC Transfer Characteristics

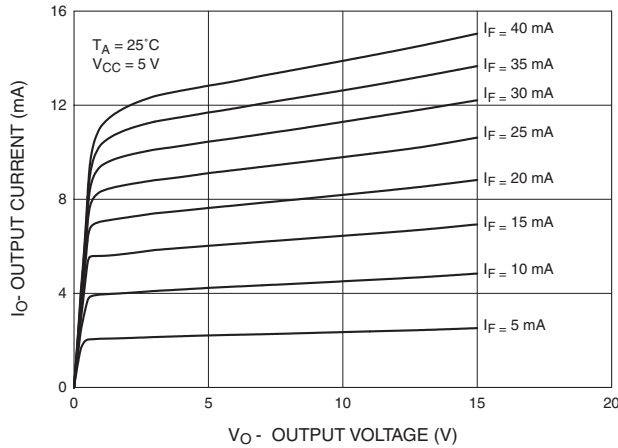

Fig. 6 Logic Low Supply Current vs. Input Current

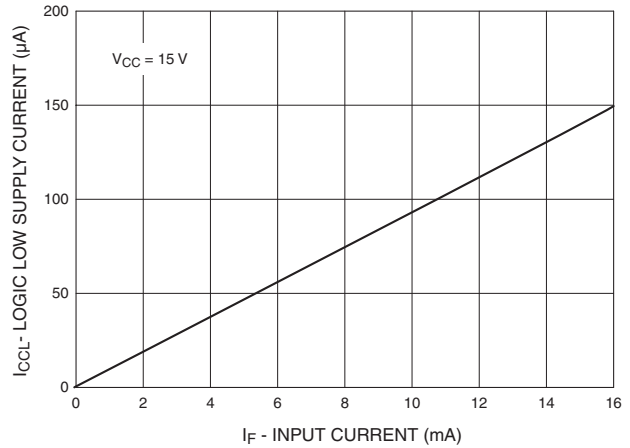

Fig. 7 Logic High Output Current vs. Temperature

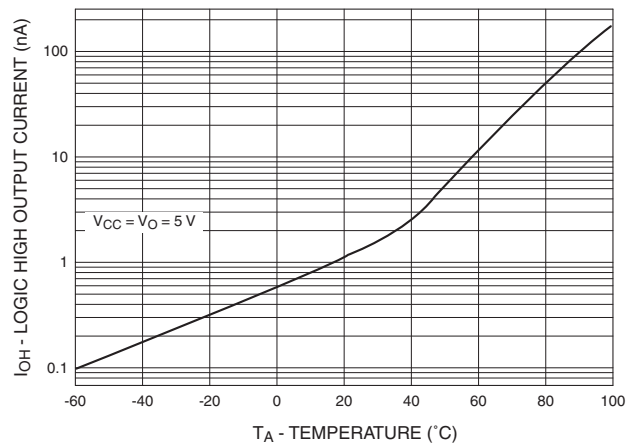
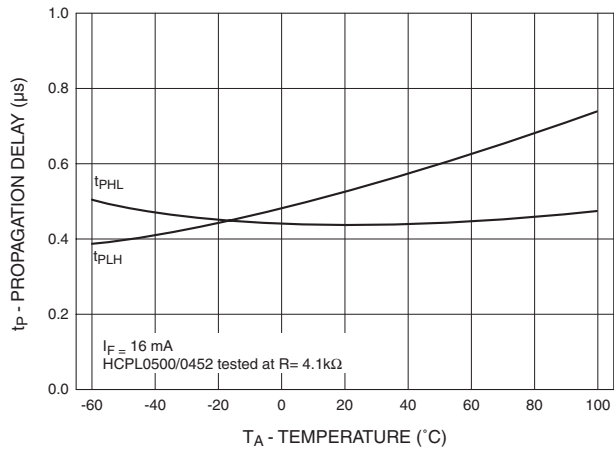

Fig. 8 Propagation Delay vs. Temperature



**SINGLE-CHANNEL
HCPL-0500 HCPL-0452
HCPL-0501**

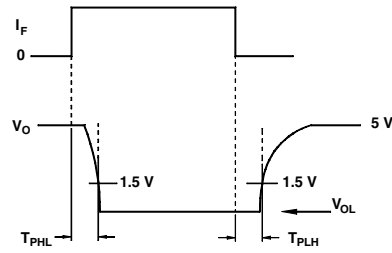
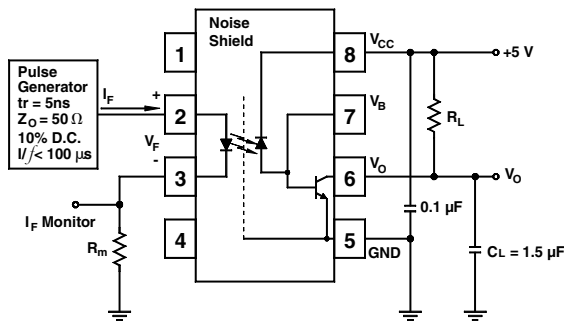

Fig. 9 Switching Time Test Circuit

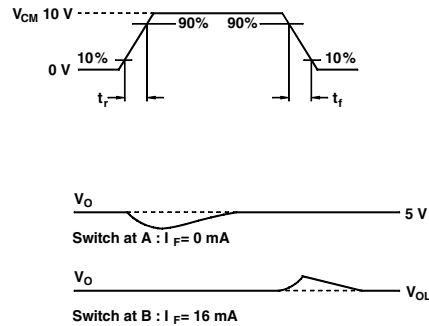
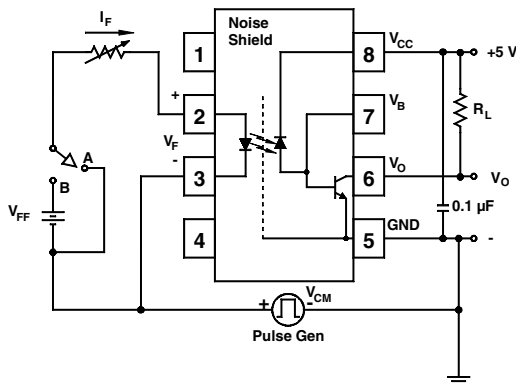

Fig. 10 Common Mode Immunity Test Circuit

**SINGLE-CHANNEL
HCPL-0500
HCPL-0501**

HCPL-0452

ORDERING INFORMATION

Option	Order Entry Identifier	Description
R1	.R1	Tape and Reel (500 per reel)
R2	.R2	Tape and Reel (2500 per reel)

QT Carrier Tape Specifications

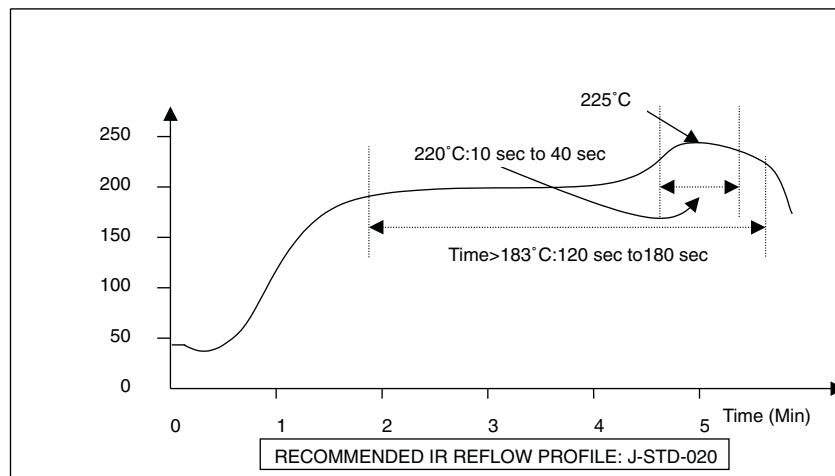
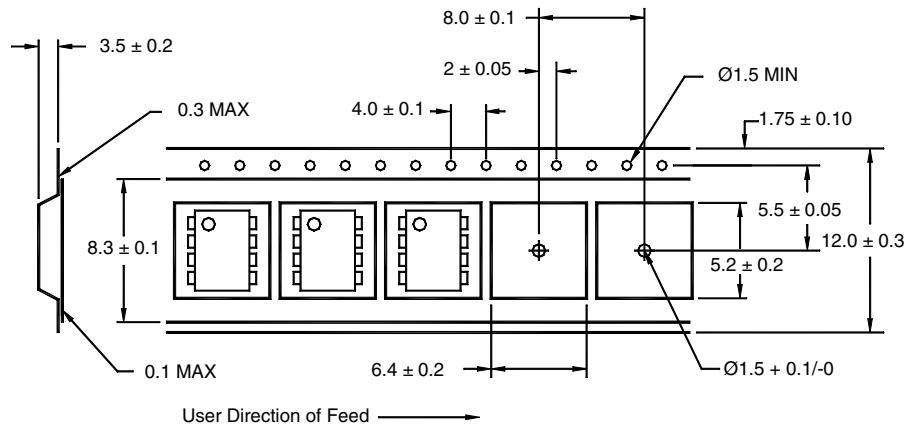

Fig. 11 JEDEC Reflow Profile

SINGLE-CHANNEL

HCPL-0500

HCPL-0452

HCPL-0501

DISCLAIMER

FAIRCHILD SEMICONDUCTOR RESERVES THE RIGHT TO MAKE CHANGES WITHOUT FURTHER NOTICE TO ANY PRODUCTS HEREIN TO IMPROVE RELIABILITY, FUNCTION OR DESIGN. FAIRCHILD DOES NOT ASSUME ANY LIABILITY ARISING OUT OF THE APPLICATION OR USE OF ANY PRODUCT OR CIRCUIT DESCRIBED HEREIN; NEITHER DOES IT CONVEY ANY LICENSE UNDER ITS PATENT RIGHTS, NOR THE RIGHTS OF OTHERS.

LIFE SUPPORT POLICY

FAIRCHILD'S PRODUCTS ARE NOT AUTHORIZED FOR USE AS CRITICAL COMPONENTS IN LIFE SUPPORT DEVICES OR SYSTEMS WITHOUT THE EXPRESS WRITTEN APPROVAL OF THE PRESIDENT OF FAIRCHILD SEMICONDUCTOR CORPORATION. As used herein:

1. Life support devices or systems are devices or systems which, (a) are intended for surgical implant into the body, or (b) support or sustain life, and (c) whose failure to perform when properly used in accordance with instructions for use provided in labeling, can be reasonably expected to result in a significant injury of the user.
2. A critical component in any component of a life support device or system whose failure to perform can be reasonably expected to cause the failure of the life support device or system, or to affect its safety or effectiveness.